



NK17 NW17

Loads up to 50N

- Linear rail with polymer slide
- Reduced size (both height and surface)
- Dry working, no maintenance required
- Not affected by dust
- Corrosion-resistant
- Reduced coefficient of friction means wear is reduced
- Reduced weight thanks to use of a combination of aluminium and plastic
- Very high speeds and acceleration possible
- Replaceable sliding parts in iglidur® J
- Materials:
 - Slide body: Plastic
 - Rails: Anodised aluminium
- Symmetrical hole pattern, C5=C6

Small but effective

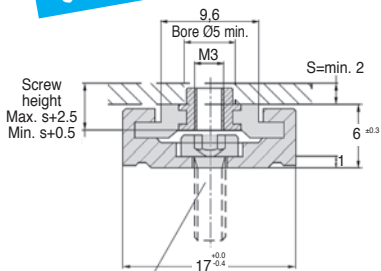

For M3 screw
DIN 7984 DIN
6912 DIN 84
EN ISO 1707

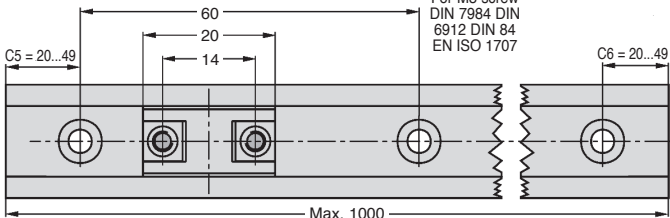

DISCOUNTS

Qty	1+	5+	10+
Disc.	List	-6%	On request

Part number	Type	Weight (g)	Stock*	Price each 1 to 4
NK02-17-1000	1 Rail (1000mm) + 1 slide	151,7	✓	47,80 €
NW02-17	1 slide only	1,7	✓	4,25 €

*Depending on availability - Dimensions in mm



Load up to 500N

NK27
NW27

- Linear rail with polymer slide
- Reduced size (both height and surface)
- Dry working, no maintenance required
- Not affected by dust
- Corrosion-resistant
- Reduced coefficient of friction means wear is reduced
- Reduced weight thanks to use of a combination of aluminium and plastic
- Very high speeds and acceleration possible
- Replaceable sliding parts in iglidur® J
- Materials:
 - Slide body: Zinc
 - Rails: Anodised aluminium
- Symmetrical hole pattern, C5=C6



NS & NW-01



NS & NW-02

Small but effective

Options

- Rail length up to 3000mm max.

For M4 screw
DIN 7984 / DIN 6912
DIN 84 / EN ISO 1707

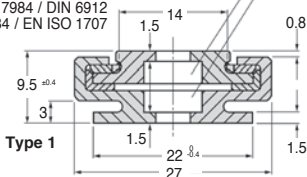

Type 1

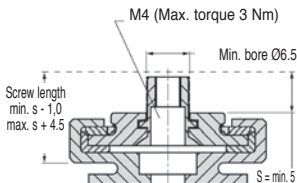

Type 2

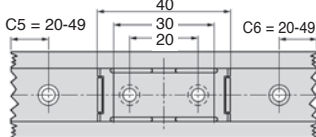

Type 1

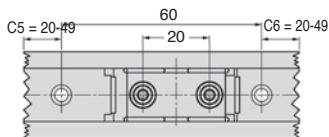

Type 2

DISCOUNTS

Qty	1+	5+	10+
Disc.	List	-6%	On request

Part number	Type	Weight (g)	Stock*	Price each 1 to 4
NK01-27-1000	1 Rail (1000mm) + 1 slide type 1	300,8	✓	61,50 €
NK02-27-1000	1 Rail (1000mm) + 1 slide type 2	302,5	✓	63,60 €
NW01-27	1 slide type 1 only	10,8	✓	4,78 €
NW02-27	1 slide type 2 only	12,5	✓	6,90 €

*Depending on availability - Dimensions in mm

NK40 NW40

Load up to 700N

- Linear rail with polymer slide
- Reduced size (both height and surface)
- Dry working, no maintenance required
- Not affected by dust
- Corrosion-resistant
- Reduced coefficient of friction means wear is reduced
- Reduced weight thanks to use of a combination of aluminium and plastic
- Very high speeds and acceleration possible
- Replaceable sliding parts in iglidur® J
- Materials:
 - Slide body: Zinc
 - Rails: Anodised aluminium
- Symmetrical hole pattern, C5=C6

Small but effective

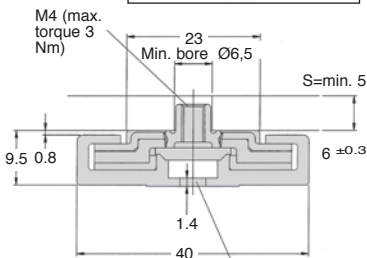

For M4 screw
DIN 7984 DIN
6912 DIN 84
EN ISO 1707
EN ISO 7045

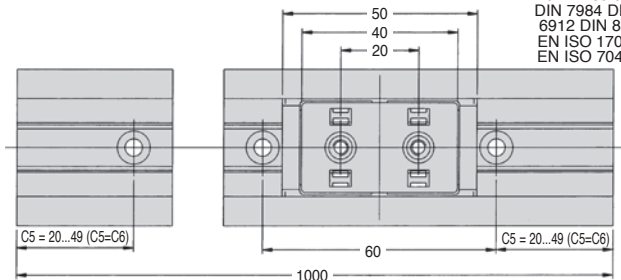

DISCOUNTS

Qty	1+	5+	10+
Disc.	List	-6%	On request

Part number	Type	Weight (g)	Stock*	Price each 1 to 4
NK02-40-1000	1 Rail (1000mm) + 1 slide	480	✓	78,21 €
NW02-40	1 slide only	30	✓	8,93 €

*Depending on availability - Dimensions in mm



DryLin® N miniature guiding system

Load up to 1000N

NK80
NW80

Small but
effective

- Linear rail with polymer slide
- Reduced size (both height and surface)
- Dry working, no maintenance required
- Not affected by dust
- Corrosion-resistant
- Reduced coefficient of friction means wear is reduced
- Reduced weight thanks to use of a combination of aluminium and plastic
- Very high speeds and acceleration possible
- Replaceable sliding parts in iglidur® J
- Materials:

Slide body: Plastic

Rails: Anodised aluminium

- Symmetrical hole pattern, C5=C6

Options

- Rail length up to 3960mm max.

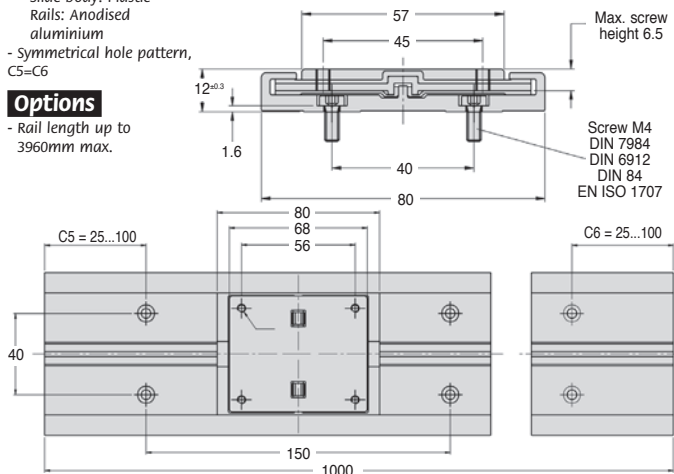
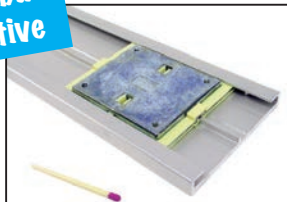

DISCOUNTS

Qty	1+	5+	10+
Disc.	List	-6%	On request

Part number	Type	Weight (g)	Stock*	Price each 1 to 4
NK02-80-1000	1 Rail (1000mm) + 1 slide	1240	✓	106,74 €
NW02-80	1 slide only	100	✓	14,12 €

*Depending on availability - Dimensions in mm

DryLin® N Rail end cap

NSKB

Accessory

- Rail end cap
- The end caps are compatible with Drylin® N guide rails and prevent carriages sliding off whilst offering an aesthetic finish and protection against cuts from sharp edges

Advantages

- Easy mounting
- Low cost
- Can be removed
- High retention force

Material

- Polymer

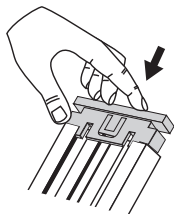
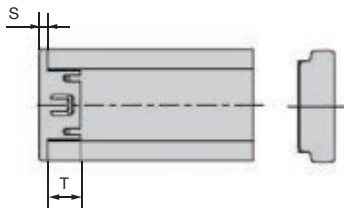

Easily assembled by hand

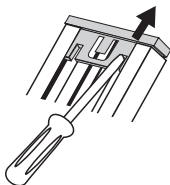

Disassembled using a screwdriver

DISCOUNTS

Qty	1+	5+	10+
Disc.	List	-6%	On request

Part number	S	T	For rail	Price each. 1 to 4
NSKB-17	1,5	7	NK02-17	8,42 €
NSKB-27	2	8	NK01-27, NK02-27	9,01 €
NSKB-40	1,5	8	NK02-40	On request
NSKB-80	2	17	NK02-80	12,37 €

Dimensions in mm

Maximum loads

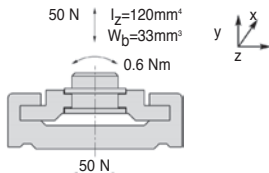

$I_y=1700\text{mm}^4$
 $W_b=200\text{mm}^3$

NK02-17

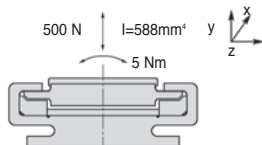

$I=6524\text{mm}^4$

NK01-27
NK02-27

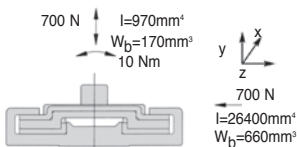

$I=26400\text{mm}^4$
 $W_b=660\text{mm}^3$

NK02-40

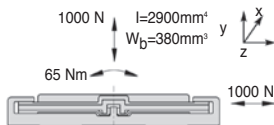

NK02-80

